

Quick Start Guide



⚠ WARNING

RISK OF SUCTION ENTRAPMENT HAZARD, WHICH IF NOT AVOIDED, CAN RESULT IN SERIOUS INJURY OR DEATH. READ THIS MANUAL IN ITS ENTIRETY BEFORE INSTALLING AND OPERATING THE CLEANER. Ensure that the vacuum suction fittings installed in your pool for connection of your suction-side pool cleaner are certified compliant with applicable safety standards, such as IAPMO SPS 4. Do not block the suction fittings in the pool, the suction opening on this product, or the cleaner hoses with any part of your body. Do not expose your hair, loose clothing, jewelry, etc. to any suction outlet fittings in the pool/spa, on this product, or on the cleaner.

For complete installation instructions, download the owner's manual from the website: www.zodiac.com.au or call the Customer Service Centre: 1300 763 021



Read owner's manual completely before operating.

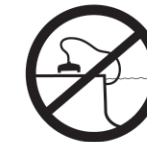

Do not operate cleaner outside of pool.



Remove cleaner before entering pool.



Do not let children play with cleaner.

For complete installation instructions, please download the manual from the website, call the customer service number or submit a written request to:

Zodiac Group Australia
219 Woodpark Road, Smithfield,
NSW 2164 Australia
1300 763 021
www.zodiac.com.au

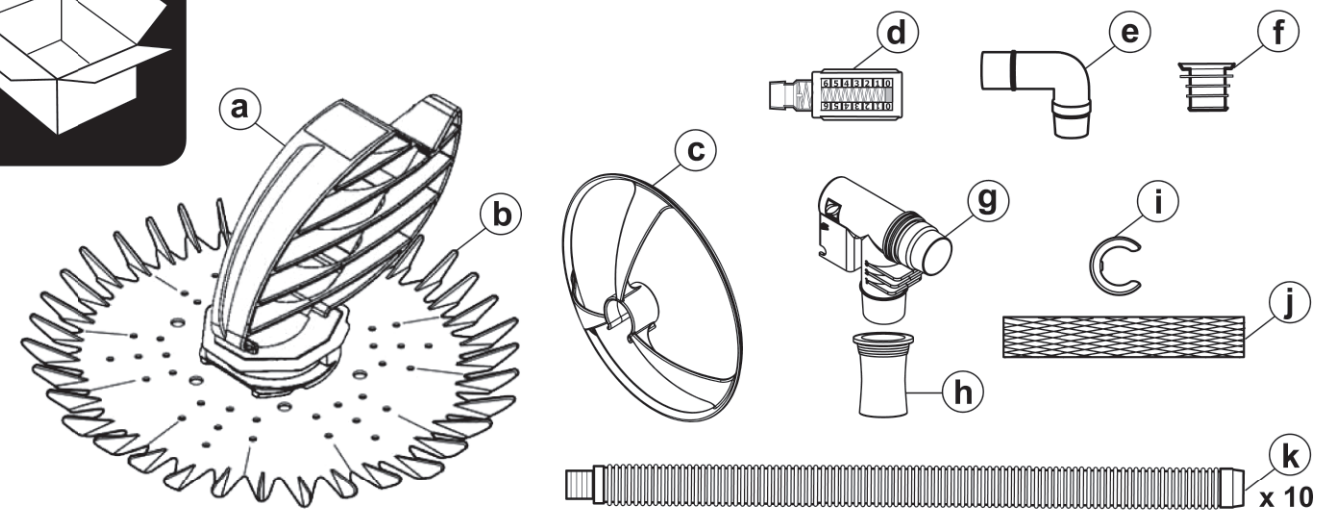

- a Cleaner Body
- b Finned Disc
- c Wheel Deflector
- d Quick Connector
- e Pool Pulse
- f 90 Degree Elbow
- g Weir Cuff
- h AD Flow Valve
- i AD Flow Valve Connector
- j Hose Weight
- k Hose Protector Net x 10

1 Turn Off the Pool Filter Pump to Avoid Serious Injury.



2 Clean pool filter and baskets. Manually vacuum the pool. Adjust return inlets down and toward each other or toward the centre of pool.

3 Install AD Valve (h) in Skimmer Box

Waterco Skimmer Box Vac Plate

Screw the AD flow valve connector (i) into the top of the Vac Plate

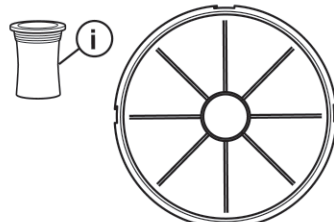

Poolrite Skimmer Box Vac Plate

Screw the AD flow valve connector (i) into the bottom of the Vac Plate

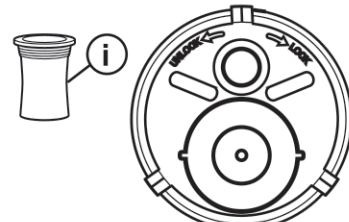

Other Skimmer Box

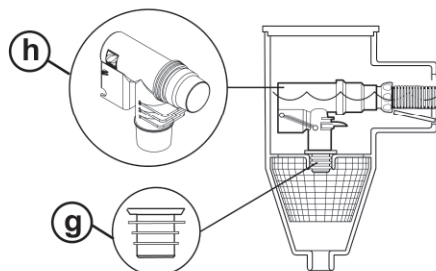

Skimmer Box with Skimtrol Vac Plate / speed regulator

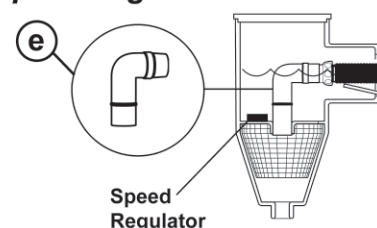

4 Assemble the Hose

Required Length of Hose = Farthest point across pool plus 2 Hose sections

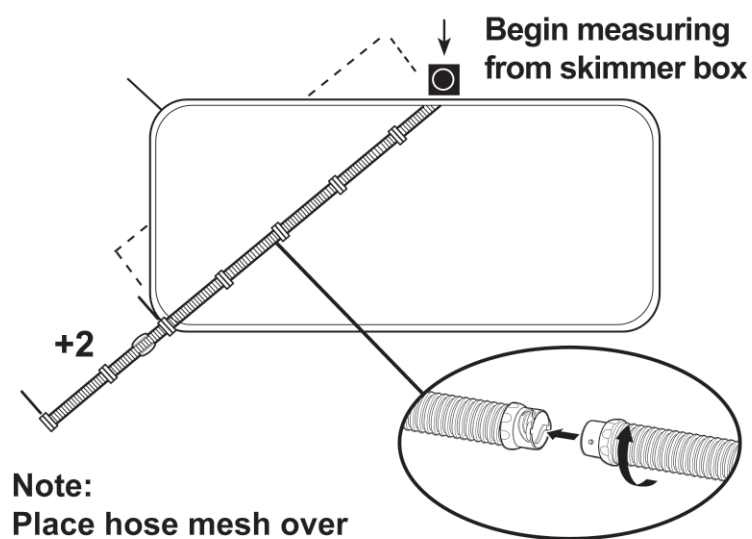

Note: Place hose mesh over first hose from the skimmer box.

5 Clip hose weight (j) 9 inches up from the hose (l) end connecting to the cleaner head.

Connect the wheel deflector (c) onto the hose as close to the cleaner head as possible.

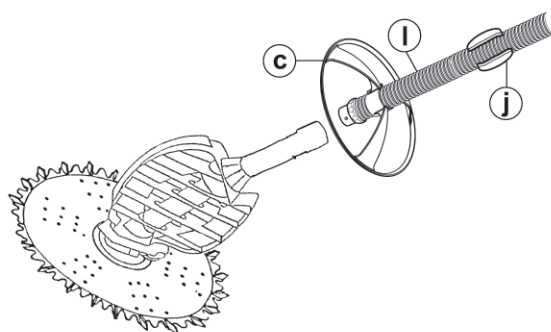

6 Before attaching the cleaner head, measure the suction flow at the hose the furthest away from the Skimmer box. Keep hose under water and connect the Pool Pulse to the hose using the Quick connector.

Extremity of the hose with Wheel Deflector and Quick Connector.

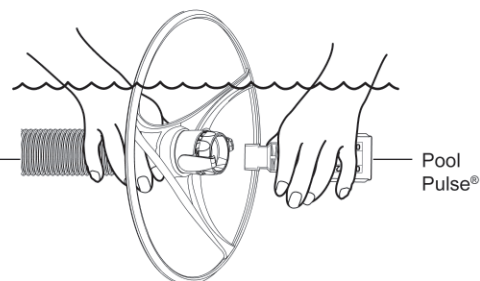

7 Turn on pool filter pump.

8

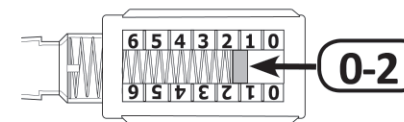
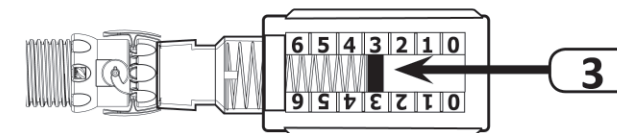

OR

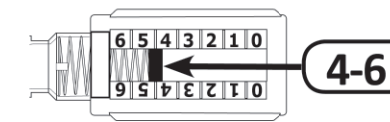

0-2: move up to 3 on the AD Valve to increase flow

4-6: move down to 1 on the AD Valve to reduce flow

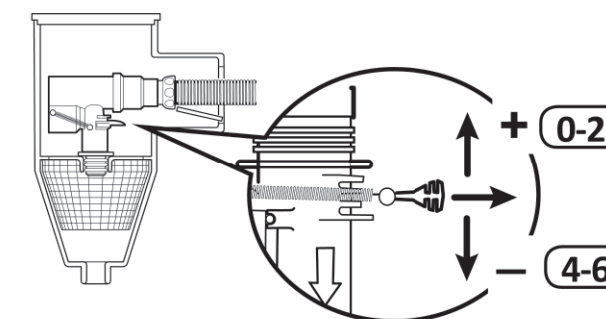

9 To avoid serious injury, turn off the pool filter pump before continuing.



10 Take out Pool Pulse and Quick Connector. Attach cleaner head by twisting the hose in place.

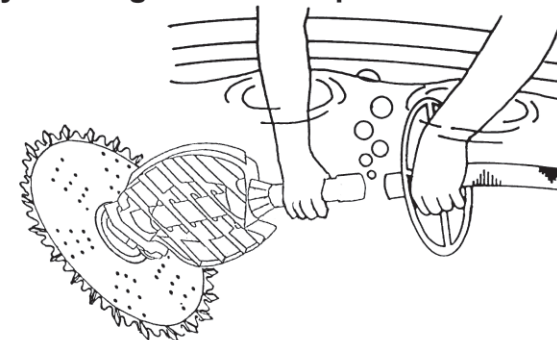

11 Turn on pool filter pump to begin cleaning.

Operations May need to adjust hose weight to have ideal position in pool.

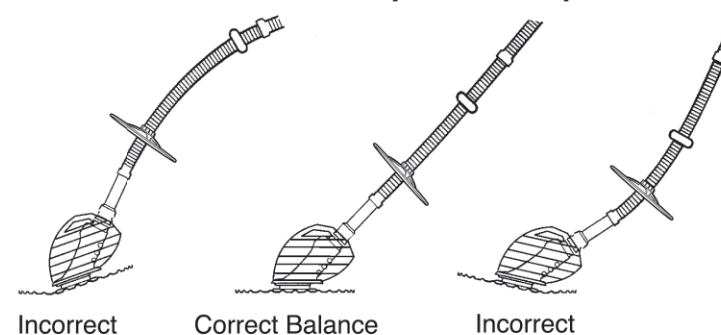

Direct return to gently push cleaner hose.

